

ELECTRICAL COMPONENTS

	PAGE
ELECTRICAL TERMINALS.....	256
FUSIBLE LINKS	262
MISCELLANEOUS ELECTRICAL	261
TERMINATED ELECTRICAL LEADS FOR FORD	263
 WIRING RETAINERS	
CLIPS & STRAPS	258
SPARK PLUG WIRE RETAINERS.....	260

ELECTRICAL COMPONENTS



ELECTRICAL TERMINALS

GENERAL PURPOSE

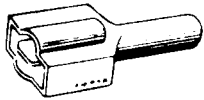

77-4613
 Wire Ga. 22-18
 Terminal. Quick Disconnect
 Female
 Fully Insulated
 General Usage
 Cars, Trucks, Appliances, Etc.
UNIT PACKAGE 50



77-4614
 Wire Ga. 22-18
 Terminal. Quick Disconnect
 Male
 Fully Insulated
 General Usage
 Cars, Trucks, Appliances, Etc.
UNIT PACKAGE 50



77-4615
 Wire Ga. 16-14
 Terminal. Quick Disconnect
 Female
 Fully Insulated
 General Usage
 Cars, Trucks, Appliances, Etc.
UNIT PACKAGE 50

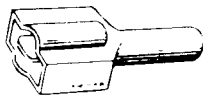

77-4616
 Wire Ga. 16-14
 Terminal. Quick Disconnect
 Male
 Fully Insulated
 General Usage
 Cars, Trucks, Appliances, Etc.
UNIT PACKAGE 50



77-4617
 Wire Ga. 12-10
 Terminal. Quick Disconnect
 Female
 Fully Insulated
 General Usage
 Cars, Trucks, Appliances, Etc.
UNIT PACKAGE 50

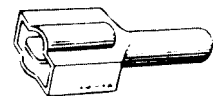

77-4618
 Wire Ga. 12-10
 Terminal. Quick Disconnect
 Male
 Fully Insulated
 General Usage
 Cars, Trucks, Appliances, Etc.
UNIT PACKAGE 50

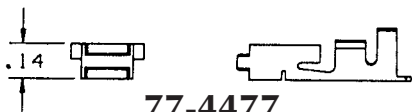
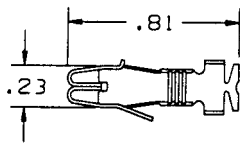

77-4477
 Replaces: 6294512, 12020346
 18 Ga., Wiring Terminal
 G.M. Directional Signals Etc.
UNIT PACKAGE 50

G.M.

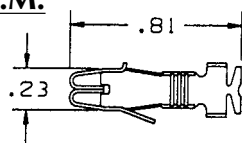

77-4662
 Replaces: 6294738
 Terminal For Two 18 or 20 Ga. Wire
 G.M. Cars & Trucks
UNIT PACKAGE 100

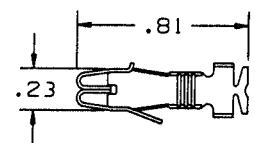

77-4661
 Replaces: 6294737, 12020347
 Terminal For One 14 or 16 Ga. Wire
 G.M. Cars & Trucks
UNIT PACKAGE 100

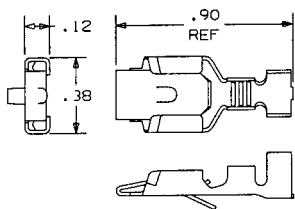

77-4664
 Replaces: 2973216
 Terminal For One 14 or 16 Ga. Wire
 G.M. Cars & Trucks
UNIT PACKAGE 100

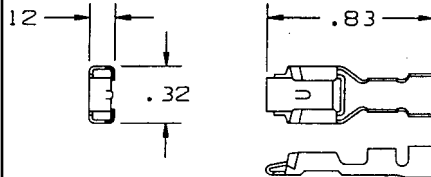

77-4665
 Replaces: 2977615
 Terminal For One 10 Ga. Wire
 Or Four 18 or 20 Ga. Wire
 G.M. Cars & Trucks
UNIT PACKAGE 100

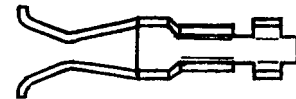

77-4699
 Replaces: 8900426
 Wiring Terminal
 General Purpose
 G.M. Cars
UNIT PACKAGE 100

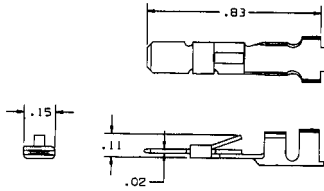

77-4547

Replaces: 6294511
18 Ga.
Wiring Terminal (Use With 77-4477)
Directional Signals & Radio Harness
G.M.
UNIT PACKAGE 50

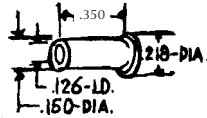

83-5681

Replaces: 6294187
Terminal. Fibre Optics
G.M.
UNIT PACKAGE 100

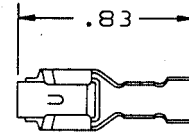

94-7258

Replaces: 2973215
Terminal Female
1-10 Ga. or 2-14 or 16 Ga. Wires
Male Tab .319 Max.
G.M. & General Purpose
UNIT PACKAGE 50

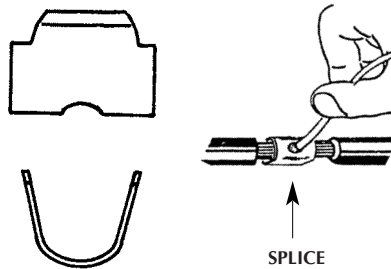

97-7749

Replaces: 05297428
SPLICE CLIP-CRIMP & DIP
(SOLDER TYPE)
Accepts: 2-18 Ga. or 2-16 Ga. Leads
G.M. & General Use
UNIT PACKAGE 50

97-7750

Replaces: 00821240
SPLICE CLIP-CRIMP & DIP
(SOLDER TYPE)
Accepts: 2-14 Ga. Leads
G.M. & General Use
UNIT PACKAGE 50

97-7751

Replaces: 01839906
SPLICE CLIP-CRIMP & DIP
(SOLDER TYPE)
Accepts: 2-12 Ga. or 2-10 Ga. Leads
G.M. & General Use
UNIT PACKAGE 50

METRI-PAK TERMINALS

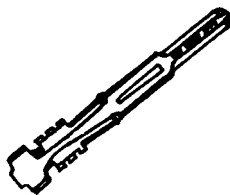

86-6174

Replaces: 12034047
Terminal (Metri-Pack) Male
2.8MM Blade Use with Female
Terminal; Car-Pak 86-6173.
18-20 Ga. Wire
UNIT PACKAGE 25

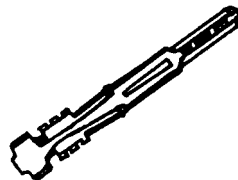

86-6172

Replaces: 12020116
Terminal. Male 2.8 MM Blade
14-16 Ga. Wire, G.M.
UNIT PACKAGE 25



86-6173

Replaces: 12034046
Terminal. Female Use with Female
2.8 MM Male Blade Terminal
Car-Pak 86-6174
18-20 Ga. Wire
UNIT PACKAGE 25

ELECTRICAL COMPONENTS



FORD & CHRYSLER

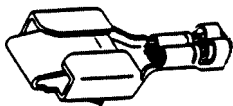

94-7297
 Replaces: E8EB-14474-SA
 Terminal Female
 16 Ga.
 Accepts .250 Male Terminal
 Ford & General Purpose
 UNIT PACKAGE 25

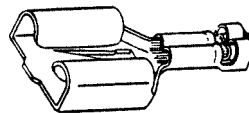

94-7298
 Replaces: D4AB-14474-JA
 Terminal Female
 12 Ga.
 Accepts .250 Male Terminal
 Ford & General Purpose
 UNIT PACKAGE 25

94-7299
 Replaces: E8EB-14474-MA
 Terminal Female
 16 Ga.
 Accepts .250 Male Terminal
 Ford & General Purpose
 UNIT PACKAGE 25



79-5111
 22-18 Ga. Wire
 Terminal Box Type
 Female
 Ford Products '72/
 UNIT PACKAGE 50



90-6726
TERMINAL
 Female 18/20 Ga.
 Mates w/Pin Style Male Terminal
 Used in Fuel Tank Sending Unit
 Ford & General Purpose
 UNIT PACKAGE 25

90-6727
TERMINAL
 Female 14/16 Ga.
 Mates w/Pin Style Male Terminal
 Used in Fuel Tank Sending Unit
 Ford & General Purpose
 UNIT PACKAGE 25

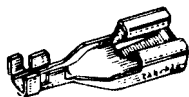

79-5056
 Replaces: 3843601
 1/4" Female Terminal
 Quick Disconnect
 14-16 Ga. Wire
 Use with 79-5009
 Chrysler Products
 UNIT PACKAGE 50

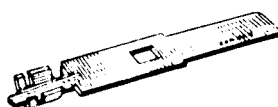

79-5009
 Replaces: 3843386
 1/4" Male Terminal
 Quick Disconnect
 14-16 Ga. Wire
 Use with 79-5056
 Chrysler Products
 UNIT PACKAGE 50



**VISIT THE REPAIR
 HARNESS SECTION FOR
 ELECTRICAL PROBLEM
 SOLVERS.**

MISCELLANEOUS RETAINERS & WIRE GUIDES



74-4059
CLIP- WIRING & TUBING
 Tube Size 1/4"
 Hole: 1/4", P.R.: 1/32"-1/8"
 General Purpose
 All Cars, All Models
 Wide Industrial Usage
 UNIT PACKAGE 50



J02143
LOOM CLIP
 Replaces: C7AB-14A163B
 Plastic, Hole: 1/4", 1/4" Tubing
 Ford Products & General Purpose
 UNIT PACKAGE 50



74-4060
 Replaces: 492033
CLIP- WIRING & TUBING
 Self-Locking
 Pontiac, G.M. Cars
 General Purpose
 UNIT PACKAGE 50





75-4156

Replaces: Tube Size 1/2"
CLIP- WIRING & TUBING
 Hole: 1/4", P.R.: 1/32"-1/8"
 Ford Products &
 General Purpose
UNIT PACKAGE 50

75-4157

Replaces: Tube Size 5/8"
CLIP- WIRING & TUBING
 Hole: 1/4", P.R.: 1/32"-1/8"
 Ford Products &
 General Purpose
UNIT PACKAGE 50

75-4158

Replaces: Tube Size 3/4"
CLIP- WIRING & TUBING
 Hole: 1/4", P.R.: 1/32"-1/8"
 Ford Products &
 General Purpose
UNIT PACKAGE 50

**Clip (Retaining)
 Convoluted Wiring Harness**

G.M.



78-4973

Replaces: 8911473
 Conduit Size .350 (9),
 Hole: M6.3, P.R.: 3.81MM
UNIT PACKAGE 50

78-4974

Replaces: 8911497
 Conduit Size .413 (10),
 Hole: M6.3, P.R.: 3.81MM
UNIT PACKAGE 50

78-4975

Replaces: 8911472
 Conduit Size .500 (13),
 Hole: M6.3, P.R.: 3.81MM
UNIT PACKAGE 50

78-4976

Replaces: 8917320
 Conduit Size .750 (19),
 Hole: M6.3, P.R.: 3.81MM
UNIT PACKAGE 50

89-6647

Replaces: 12015983
 Conduit Size 1.125 (25),
 Hole: M6.3, P.R.: 3.81MM
UNIT PACKAGE 25

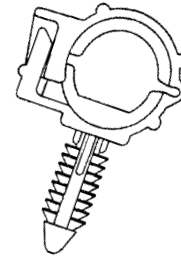

99-8457

Replaces: 12084887
CLIP-CONVOLUTED CONDUIT
 Plastic
 For 10/13MM (.413/.500) Conduit,
 Hole: M6.35 (1/4"), P.R.: 12.5MM (1/2")
 G.M. & General Purpose
UNIT PACKAGE 25

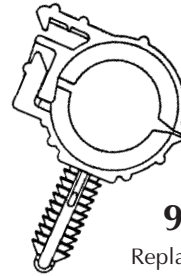

99-8458

Replaces: 12176839
CLIP-CONVOLUTED CONDUIT
 Plastic
 For 16MM (.625) Conduit,
 Hole: M6.35 (1/4"), P.R.: 12.5MM (1/2")
 G.M. & General Purpose
UNIT PACKAGE 25

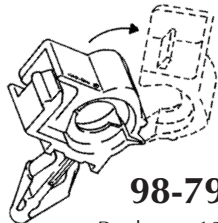

98-7904

Replaces: 12015631
CLIP-RETAINING, WIRE HARNESS
 Convoluted Wire Loom
 For .250 (6) Convoluted Conduit
 Hole: M6.3, P.R.: 3.80 MM
 Anti Lock Brake Wiring at Lower Control
 Arm & General Purpose
UNIT PACKAGE 15

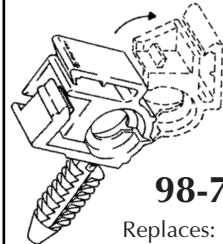

98-7905

Replaces: 12040984
CLIP-RETAINING, WIRE HARNESS
 Convoluted Wire Loom
 For .250 (6) Convoluted Conduit
 Hole: M6.3, P.R.: 12.5MM
 Anti Lock Brake Wiring at Lower Control
 Arm & General Purpose
UNIT PACKAGE 10

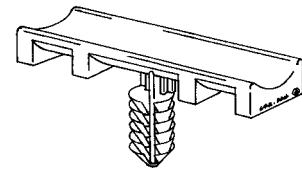

99-8256

Replaces: 12160857
RETAINER - WIRE HARNESS, TAPE ON
 Plastic
 Hole: M6.3, Length: 36.5MM
 G.M. & General Purpose
UNIT PACKAGE 50

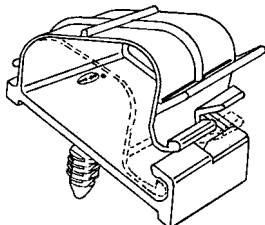

84-5883

Replaces: 20491451
WIRE CLIP- ENGINE COMPARTMENT
 Plastic
 G.M. '80/
UNIT PACKAGE 10

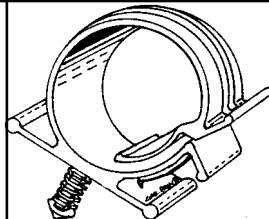

86-6161

Replaces: 20562202
CLIP-WIRING
 1-1/2" I.D. 1-7/8" OD
 Fits 1/4" (6.3MM) Hole
 G.M. Cars & General Purpose
UNIT PACKAGE 15

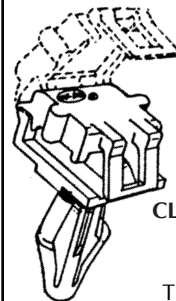

85-5927

Replaces: 8917236
CLIP- WIRING HARNESS
 up to 3 Leads
 Hole: 1/4"
 Thickness Range: 5/32"
 Plastic
 Various Application
 Corvette, Chevrolet, Buick, Olds
 G.M.C. Trucks '82/
UNIT PACKAGE 25

ELECTRICAL COMPONENTS



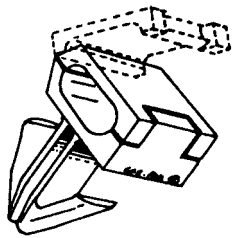

87-6263

GUIDE-WIRE CABLE
 Guide Opening 5/32" x 1/4";
 Hole: 1/4"; Panel Range: .035 - .090
 Plastic
 General Use
 UNIT PACKAGE 50

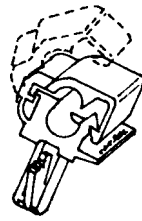

88-6505

Replaces: 20087231
RETAINER-HOOD RELEASE CABLE
 G.M. Various Models '80/
 UNIT PACKAGE 25

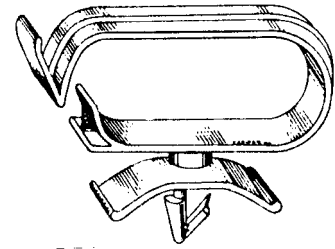

77-4458

Replaces: 1242676
RETAINER- BATTERY CABLE
 Buick, Olds, Pontiac '73/
 UNIT PACKAGE 50

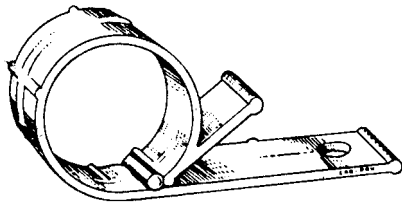

77-4442

Replaces: 409584
CLIP- WIRE HARNESS TUBING
 G.M. '72/
 UNIT PACKAGE 50

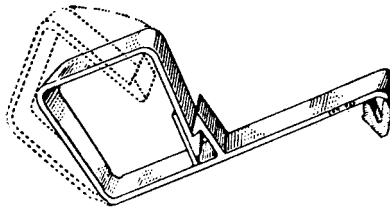

76-4286

Replaces: 492032
RETAINER- WIRING & TUBING
 Self-Locking
 Pontiac '76
 UNIT PACKAGE 50

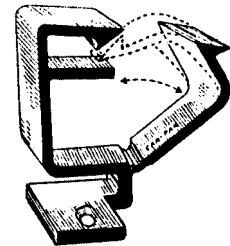

80-5207

Replaces: 496357
RETAINER- WIRING & TUBING
 G.M. '75
 UNIT PACKAGE 50

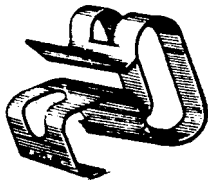

72-3709

Replaces: 9870770
CLIP- TRUNK WIRING
 G.M. Cars '71 - '72
 UNIT PACKAGE 50

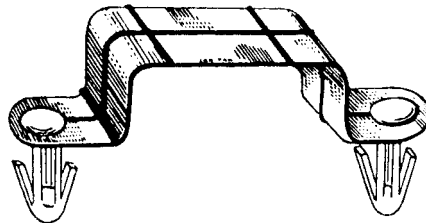

76-4277

Replaces: 403106
STRAP- WIRING & TUBING
 Plastic
 Olds
 UNIT PACKAGE 50



75-4167

Replaces: 9793719
STRAP- WIRING & HOSE
 Heater & Air Conditioning
 Length: 8-3/4"
 Pontiac '73 - '74, Buick '70 - '76
 UNIT PACKAGE 25



75-4166

Replaces: 1484957
STRAP- WIRING & HOSE
 Length: 2-1/4"
 Pontiac & Olds
 UNIT PACKAGE 50

CLOSED

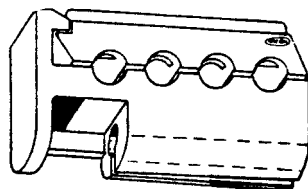

84-5861

Replaces: 6294103
RETAINER-SPARK PLUG WIRE
 4-7MM Wires
 G.M. Cars & Trucks
 UNIT PACKAGE 25

OPEN

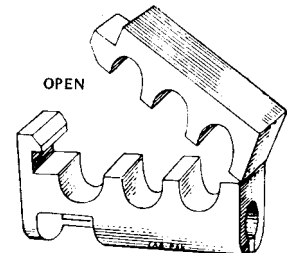

93-7182

Replaces: 8905417
RETAINER-SPARK PLUG WIRE
 3-7MM Wires
 G.M. Cars & Trucks '68/
 UNIT PACKAGE 5

CLOSED

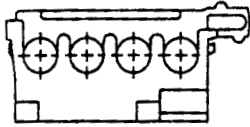
**99-8005**

Replaces: 12020704
RETAINER-SPARK PLUG WIRES
 Holds 4-8MM Wires
 G.M. '74/
UNIT PACKAGE 10

CLOSED

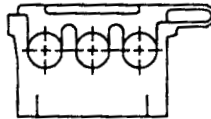
**99-8006**

Replaces: 12084623
RETAINER-SPARK PLUG WIRES
 Holds 3-8MM Wires
 G.M. '74/
UNIT PACKAGE 10

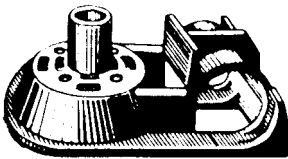
MISCELLANEOUS ELECTRICAL**71-3533**

Replaces: 409374
HARNESS- ALTERNATE WIRE HARNESS
 Nylon
 Self-Locking for 1/4" - 20 Stud
 Olds '70 - '72
UNIT PACKAGE 50

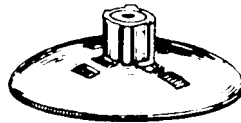
**71-3532**

Replaces: 404095
RELAY CAP PROTECTOR
 Nylon
 For 1/4" - 20 Stud
 Olds '68 - '72
UNIT PACKAGE 50

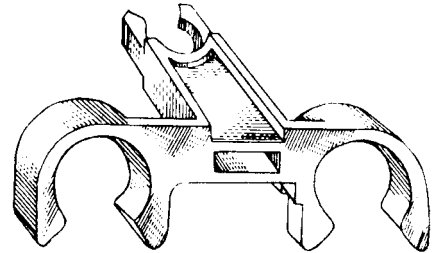
**78-4944**

Replaces: 10006953
RETAINER- SPARK PLUG WIRE
 G.M. Cars '79
UNIT PACKAGE 50

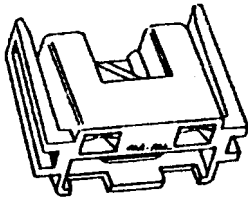
**84-5763**

Not Supplied By O.E.
CONNECTOR--TERMINAL BLOCK
 Module Coil Harness to Distributor
 G.M. 4-Cylinder Engine '78/
 Using Terminal Block #'s
 1879700, 1984298, 1892262
UNIT PACKAGE 10

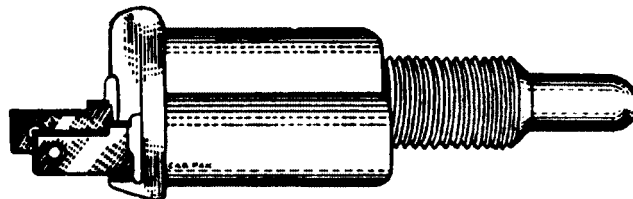
**72-3635**

Replaces: C9AZ-14A011-A
**LIMIT SWITCH-
 TAIL GATE WINDOW**
 Ford Falcon, Torino (Station Wagon) '67 - '71
UNIT PACKAGE 6

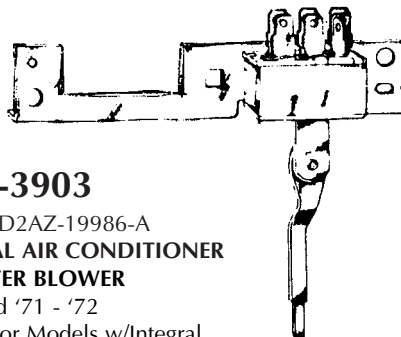
**73-3903**

Replaces: D2AZ-19986-A
**SWITCH-MANUAL AIR CONDITIONER
 & HEATER BLOWER**
 T-Bird '71 - '72
 Other Ford Motor Models w/Integral
 Air Conditioner & Heater
UNIT PACKAGE 6

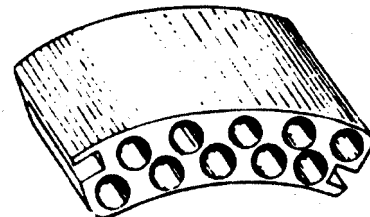
**70-3417**

Replaces: C8AZ-14489-S
**WIRE CONNECTOR-
 IGNITION FEED**
 Ford Products '68 - '70
UNIT PACKAGE 25

ELECTRICAL COMPONENTS



FUSIBLE LINKS

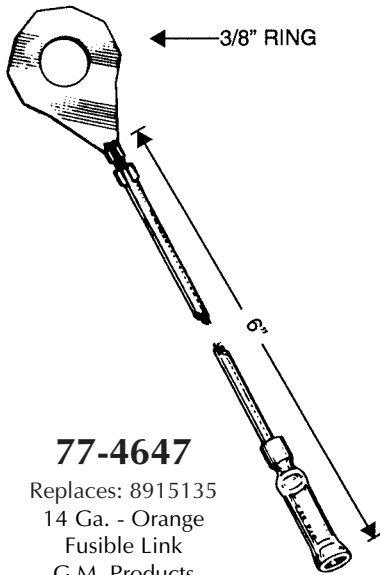

77-4647
 Replaces: 8915135
 14 Ga. - Orange
 Fusible Link
 G.M. Products
 UNIT PACKAGE 12

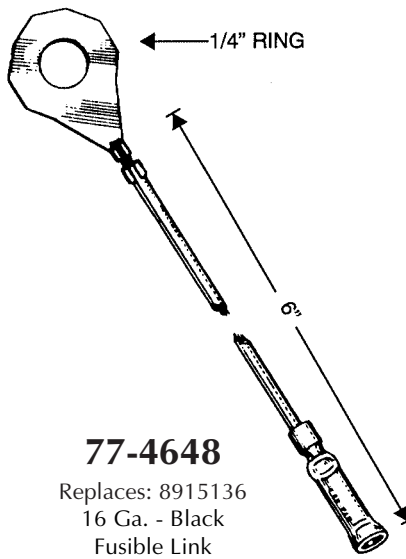

77-4648
 Replaces: 8915136
 16 Ga. - Black
 Fusible Link
 Olds
 UNIT PACKAGE 12

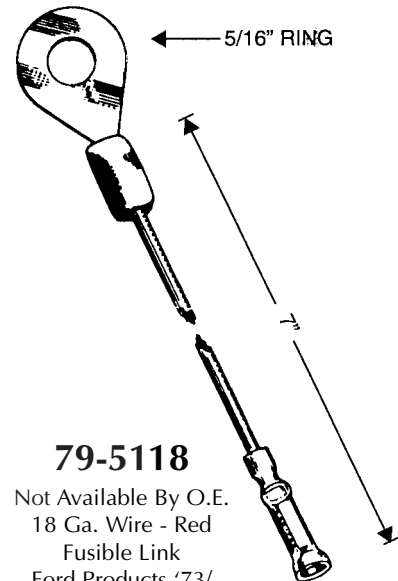

79-5118
 Not Available By O.E.
 18 Ga. Wire - Red
 Fusible Link
 Ford Products '73/
 UNIT PACKAGE 10

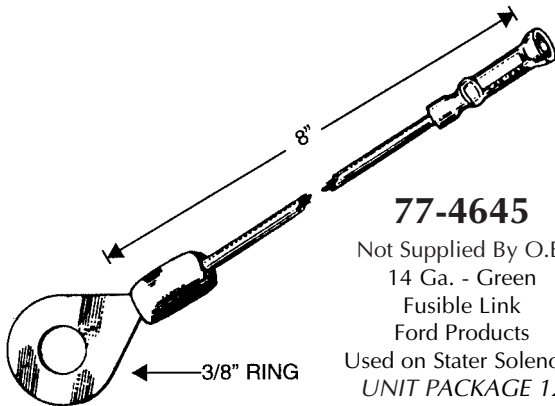

77-4645
 Not Supplied By O.E.
 14 Ga. - Green
 Fusible Link
 Ford Products
 Used on Stater Solenoid
 UNIT PACKAGE 12

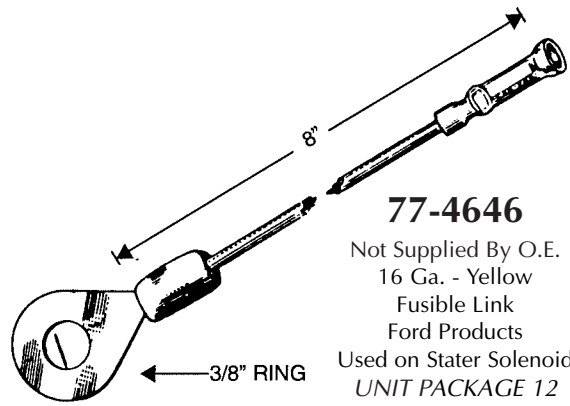

77-4646
 Not Supplied By O.E.
 16 Ga. - Yellow
 Fusible Link
 Ford Products
 Used on Stater Solenoid
 UNIT PACKAGE 12

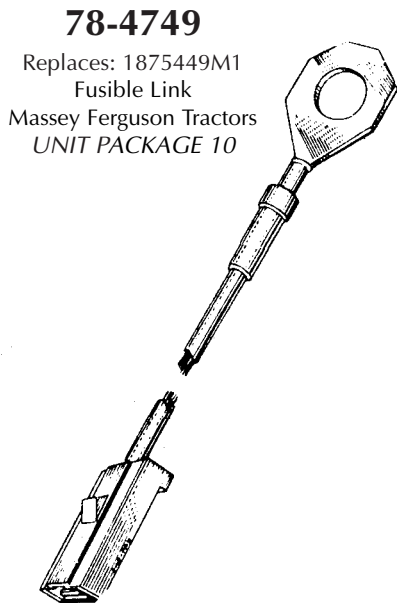

78-4749
 Replaces: 1875449M1
 Fusible Link
 Massey Ferguson Tractors
 UNIT PACKAGE 10

75-4213
 Replaces: 3843392
 18 Ga. 8" Lead
 Fusible Link, Ignition Switch
 Feed, Windshield Wiper & Washer
 Chrysler Products 'B' Bodies
 UNIT PACKAGE 12



75-4212
 Replaces: 3843345
 16 Ga. 8" Lead
 Fusible Link, Battery Feed
 Heated Rear Window, Ignition
 Switch Feed, Field-Loads Relay
 Alternator, Windshield Wiper &
 Washer
 Chrysler Products
 UNIT PACKAGE 12

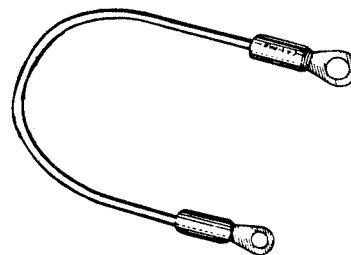

78-4744
 Replaces:
 16 Ga.
 Fusible Link
 U.S. Post Office Jeeps
 Built By American Motors
 UNIT PACKAGE 10

TERMINATED ELECTRICAL LEADS FOR FORD HARNESS REPAIRS

**READY
TO
SPLICE**

**FAST EASY WAY
TO MAKE
HARNESS REPAIRS**

**HIGH TEMP
SXL WIRE
LEADS**

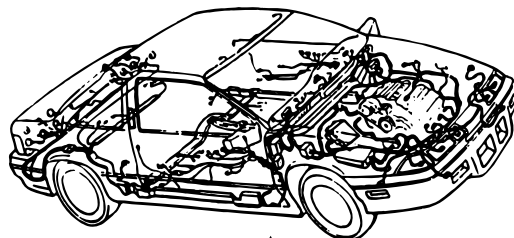

**POSITIVE
MACHINE
CRIMP**

**HIGH TEMP
"SXL" 4"
WIRE LEAD**

**NO
LOOSE ENDS
SEMI STRIPPED**

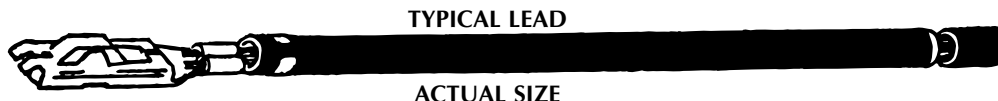

94-7260

Replaces: 101011
Term: E8EB-14461-BA
Dwr. A1
UNIT PACKAGE 10



Pin, Male
12 ga. wire

94-7261

Replaces: 101012
Term: E8EB-14461-AA
Dwr. A2
UNIT PACKAGE 10



Pin, Male
16 ga. wire

97-7645

Replaces 103901
Term: E8LB-14461-AA
Dwr. A10
UNIT PACKAGE 10

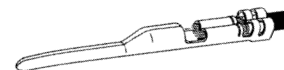

Micro Pin, Male
20 ga. wire

94-7262

Replaces: 101013
Term: E8EB-14461-JA
Dwr. A3
UNIT PACKAGE 10

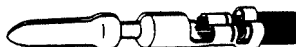

Pin, Male
12 ga. wire

94-7264

Replaces 101021
Term: E8EB-14488-UA
Dwr. B2
UNIT PACKAGE 10

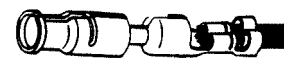

Pin Receptacle, Female
16 ga. wire

94-7263

Replaces: 101014
Term: E8EB-14461-HA
Dwr. A4
UNIT PACKAGE 10

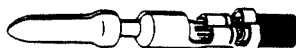

Pin, Male
16 ga. wire

94-7265

Replaces 101023
Term: E8EB-14488-ADA
Dwr. B4
UNIT PACKAGE 10

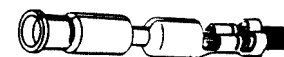

Pin Receptacle, Female
16 ga. wire

94-7335

Replaces 101019
Term: E3VB-14461-AA
Dwr. A9
UNIT PACKAGE 10



Pin, Male
18 ga. wire

94-7266



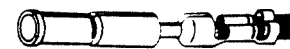





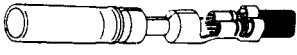
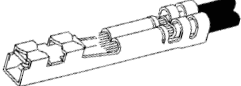

Replaces 101024
Term: E7EB-14488-NA
Dwr. B5
UNIT PACKAGE 10

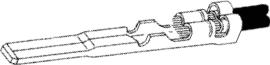
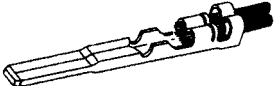

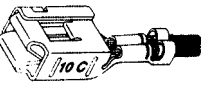
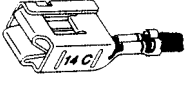
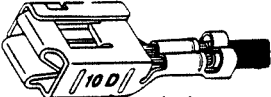

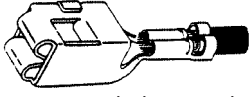
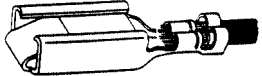
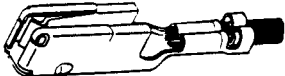
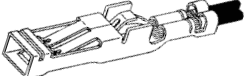

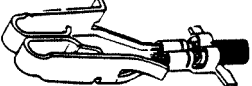
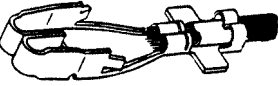

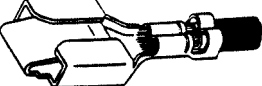
Mini Pin Receptacle, Female
16 ga. wire

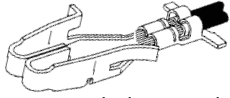
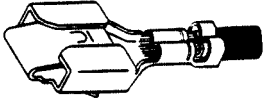
ELECTRICAL COMPONENTS

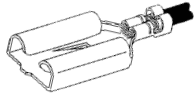
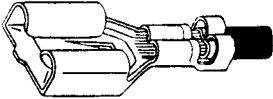
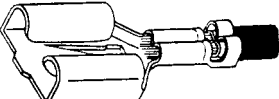
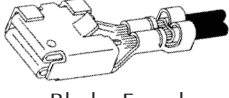
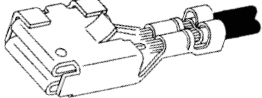
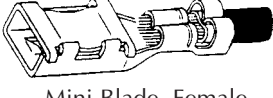
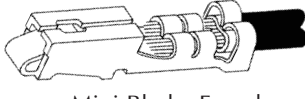

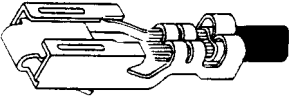
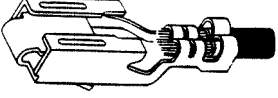
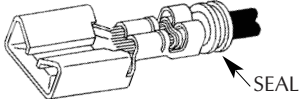
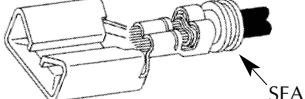
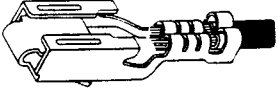
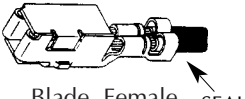

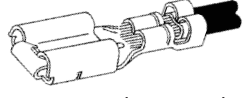
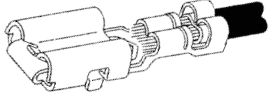
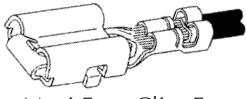
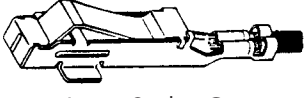

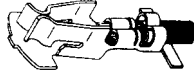
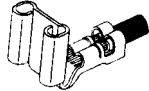
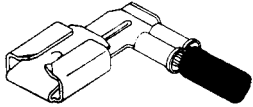

<p>94-7336 Replaces 101027 Term: E3VB-14488-AA Dwr. B8 UNIT PACKAGE 10</p>	 <p>Micro Pin Receptacle, Female 18 ga. wire</p>	<p>94-7267 Replaces 101028 Term: E7EB-14487-GA Dwr. B9 UNIT PACKAGE 10</p>	 <p>Mini Pin Receptacle, Female 16 ga. wire</p>	<p>97-7646 Replaces 103904 Term: E8LB-14487-AA Dwr. B12 UNIT PACKAGE 10</p>	 <p>Micro Pin Receptacle, Female 20 ga. wire</p>	<p>94-7337 Replaces 101030 Term: F0EB-14421-DA Dwr. C2 UNIT PACKAGE 10</p>	 <p>Blade, Male 16 ga. wire</p>	<p>95-7407 Replaces 101032 Term: E8EB-14421-CA Dwr. C4 UNIT PACKAGE 10</p>	 <p>Blade, Male 12 ga. wire</p>	<p>97-7647 Replaces 103905 Term: E8UB-14421-BA Dwr. C5 UNIT PACKAGE 10</p>	 <p>Micro Blade, Female 16 ga. wire</p>	<p>97-7648 Replaces 103906 Term: E99B-14421-BA Dwr. C6 UNIT PACKAGE 10</p>	 <p>Mini Blade, Male 16 ga. wire</p>	<p>94-7268 Replaces 101033 Term: E8EB-14474-TA Dwr. D1 UNIT PACKAGE 10</p>	 <p>Blade, Female 12 ga. wire</p>	<p>94-7269 Replaces 101034 Term: E8EB-14474-VA Dwr. D2 UNIT PACKAGE 10</p>	 <p>Blade, Female 16 ga. wire</p>	<p>95-7408 Replaces 101035 Term: F10B-14474-BA Dwr. D3 UNIT PACKAGE 10</p>	 <p>Blade, Female 12 ga. wire</p>	<p>95-7409 Replaces 101036 Term: F10B-14474-AA Dwr. D4 UNIT PACKAGE 10</p>	 <p>Blade, Female 16 ga. wire</p>	<p>94-7270 Replaces 101037 Term: E8EB-14474-XA Dwr. D5 UNIT PACKAGE 10</p>	 <p>Blade, Female 12 ga. wire</p>	<p>94-7271 Replaces 101038 Term: E8EB-14474-YA Dwr. D6 UNIT PACKAGE 10</p>	 <p>Blade, Female 16 ga. wire</p>	<p>94-7272 Replaces 101040 Term: E8EB-14474-AJA Dwr. D8 UNIT PACKAGE 10</p>	 <p>Mini Blade, Female 16 ga. wire</p>	<p>94-7273 Replaces 101042 Term: E8EB-14474-AMA Dwr. D10 UNIT PACKAGE 10</p>	 <p>Micro Blade, Female 16 ga. wire</p>	<p>94-7275 Replaces 101046 Term: E8EB-14474-BFA Dwr. D14 UNIT PACKAGE 10</p>	 <p>Mini Blade, Female 16 ga. wire</p>	<p>97-7640 Replaces 101052 Term: E27B-14474-BA Dwr. D20 UNIT PACKAGE 10</p>	 <p>Mini Blade, Female 16 ga. wire</p>	<p>97-7641 Replaces 101054 Term: E99B-14474-AA Dwr. D21 UNIT PACKAGE 10</p>	 <p>Mini Blade, Female 18 ga. wire</p>	<p>94-7276 Replaces 101055 Term: E3SB-14474-GA Dwr. D22 UNIT PACKAGE 10</p>	 <p>Blade, Female 16 ga. wire</p>	<p>94-7277 Replaces 101056 Term: E3SB-14474-BA Dwr. D23 UNIT PACKAGE 10</p>	 <p>Blade, Female 16 ga. wire</p>	<p>94-7278 Replaces 101058 Term: E8EB-14474-AXA Dwr. D25 UNIT PACKAGE 10</p>	 <p>Blade, Female 16 ga. wire</p>	<p>94-7279 Replaces 101059 Term: E8EB-14474-SA Dwr. D26 UNIT PACKAGE 10</p>	 <p>Blade, Female 16 ga. wire</p>
---	---	---	--	--	---	---	--	---	--	---	--	---	---	---	--	---	--	---	--	---	--	---	--	---	--	--	---	---	--	---	---	--	---	--	---	--	--	--	--	---	--	--	--

<p>97-7642 Replaces 101060 Term: D4SB-14474-BA Dwr. D26A UNIT PACKAGE 10</p>	 <p>Blade, Female 18 ga. wire</p>	<p>94-7280 Replaces 101062 Term: E8EB-14474-PA Dwr. D27 UNIT PACKAGE 10</p>	 <p>Blade, Female 12 ga. wire</p>	<p>97-7643 Replaces 101063 Term: E57B-14474-BA Dwr. D29 UNIT PACKAGE 10</p>	 <p>Blade, Female 12 ga. wire</p>	<p>97-7644 Replaces 101065 Term: E57B-14474-CA Dwr. D30 UNIT PACKAGE 10</p>	 <p>Blade, Female 16 ga. wire</p>	<p>94-7281 Replaces 101067 Term: D4AB-14474-JA Dwr. D32 UNIT PACKAGE 10</p>	 <p>Blade-Brass, Female 12 ga. wire</p>	<p>94-7282 Replaces 101068 Term: E8EB-14474-MA Dwr. D33 UNIT PACKAGE 10</p>	 <p>Blade, Female 16 ga. wire</p>	<p>97-7649 Replaces 103917 Term: F0VB-14474-VB Dwr. D34 UNIT PACKAGE 10</p>	 <p>Blade, Female 12 ga. wire</p>	<p>97-7650 Replaces 103918 Term: F0VB-14474-TB Dwr. D35 UNIT PACKAGE 10</p>	 <p>Blade, Female 16 ga. wire</p>	<p>94-7287 Replaces 103924 Term: F0VB-14474-AA Dwr. D41 UNIT PACKAGE 10</p>	 <p>Mini Blade, Female 18 ga. wire</p>	<p>97-7651 Replaces 103926 Term: E93B-14474-AA Dwr. D43 UNIT PACKAGE 10</p>	 <p>Mini Blade, Female 16 ga. wire</p>	<p>94-7350 Replaces 103930 Term: E83B-14474-AA Dwr. D47 UNIT PACKAGE 10</p>	 <p>Mini Blade, Female 16 ga. wire</p>	<p>94-7353 Replaces 103936 Term: E8LB-14474-FA Dwr. D53 UNIT PACKAGE 10</p>	 <p>Blade, Female 12 ga. wire</p>	<p>94-7354 Replaces 103937 Term: E93B-14474-BA Dwr. D54 UNIT PACKAGE 10</p>	 <p>Blade, Female 16 ga. wire</p>	<p>97-7654 Replaces 103942 Term: E9DB-14474-AA Dwr. D59 UNIT PACKAGE 10</p>	 <p>Blade, Female 16 ga. wire</p>	<p>97-7655 Replaces 103943 Term: E9DB-14474-BA Dwr. D60 UNIT PACKAGE 10</p>	 <p>Blade, Female 12 ga. wire</p>	<p>94-7355 Replaces 103946 Term: F0LB-14474-AA Dwr. D63 UNIT PACKAGE 10</p>	 <p>Blade, Female 18 ga. wire</p>	<p>95-7416 Replaces 103948 Term: F2DB-14478-AA Dwr. D65 UNIT PACKAGE 10</p>	 <p>Blade, Female 12 ga. wire</p>	<p>94-7283 Replaces 101069 Term: E8EB-14474-ACA Dwr. E1 UNIT PACKAGE 10</p>	 <p>Edge Card Electronic Modules & Instrument Clusters 12 ga. wire</p>	<p>97-7658 Replaces 103954 Term: F2AB-14474-LA Dwr. F8 UNIT PACKAGE 10</p>	 <p>Fuse Clip, Female 16 ga. wire</p>	<p>97-7659 Replaces 103955 Term: F2AB-14474-DA Dwr. F9 UNIT PACKAGE 10</p>	 <p>Maxi Fuse Clip, Female 16 ga. wire</p>	<p>97-7660 Replaces 103956 Term: F2AB-14474-FA Dwr. F10 UNIT PACKAGE 10</p>	 <p>Maxi Fuse Clip, Female 12 ga. wire</p>	<p>94-7338 Replaces 101080 Term: E7EB-14490-BA Dwr. G3 UNIT PACKAGE 10</p>	 <p>Lamp Socket Contact 18 ga. wire</p>
---	--	--	--	--	--	--	--	--	--	--	---	--	--	--	--	--	---	--	---	--	---	--	--	--	--	--	--	--	--	--	--	--	--	--	---	---	--	---	---	--	---	---	--

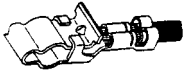
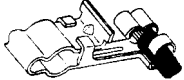
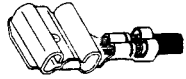
ELECTRICAL COMPONENTS

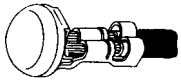

<p>95-7412 Replaces 101083 Term: C6MB-13702-A Dwr. G6 UNIT PACKAGE 10</p>	 <p>Lamp Socket Contact 16 ga. wire</p>	<p>94-7285 Replaces 101086 Term: D0VB-14474-D Dwr. H3 UNIT PACKAGE 10</p>	 <p>Blade 90°, Female 12 ga. wire</p>
<p>94-7341 Replaces 101093 Term: E7EB-14490-EA Dwr. H10 UNIT PACKAGE 10</p>	 <p>Right Angle, Blade, Female 12 ga. wire</p>	<p>94-7342 Replaces 101095 Term: E8EB-14488-AFA Dwr. I1 UNIT PACKAGE 10</p>	 <p>Right Angle Lamp Socket Contact, 18 ga. wire</p>
<p>94-7343 Replaces 101096 Term: E8EB-14488-AGA, F8AB-14488-BA Dwr. I2 UNIT PACKAGE 10</p>	 <p>Female Terminal Power Window & Lock Contact 16 ga. wire</p>	<p>94-7344 Replaces 101097 Term: E8EB-14488-AHA, F8AB-14488-AA Dwr. I3 UNIT PACKAGE 10</p>	 <p>Female Terminal Power Window & Lock Contact 16 ga. wire</p>
<p>94-7345 Replaces 101099 Term: E9EB-14474-DA Dwr. J2 UNIT PACKAGE 10</p>	 <p>Female Terminal Heated Rear Glass 12 ga. wire</p>	<p>94-7346 Replaces 101100 Term: E8EB-14474-BCA Dwr. J3 UNIT PACKAGE 10</p>	 <p>Female Terminal Heated Rear Glass 12 ga. wire</p>
<p>94-7348 Replaces 101104 Term: E8EB-14463-RA Dwr. L1 UNIT PACKAGE 10</p>	 <p>Eyelet Terminal 1/4" (M6.3) bolt hole 16 ga. wire</p>	<p>94-7356 Replaces 103959 Term: E9DB-14463-BA Dwr. L4 UNIT PACKAGE 10</p>	 <p>Eyelet Terminal 1/4" (M6.3) bolt hole 12 ga. wire</p>
<p>95-7414 Replaces 101106 Term: E8EB-14490-BA Dwr. M1 UNIT PACKAGE 10</p>	 <p>Bulb Contact 16 ga. wire</p>		

REPAIR KIT DRAWER POSITION

DRAWER #	CAR-PAK #	DRAWER #	CAR-PAK #	DRAWER #	CAR-PAK #
A1	94-7260	D8	94-7272	D59	97-7654
A2	94-7261	D10	94-7273	D60	97-7655
A3	94-7262	D14	94-7275	D63	94-7355
A4	94-7263	D20	97-7640	D65	95-7416
A9	94-7335	D21	97-7641	E1	94-7283
A10	97-7645	D22	94-7276	F8	97-7658
B2	94-7264	D23	94-7277	F9	97-7659
B4	94-7265	D25	94-7278	F10	97-7660
B5	94-7266	D26	94-7279	G3	94-7338
B8	94-7336	D26A	97-7642	G6	95-7412
B9	94-7267	D27	94-7280	H3	94-7285
B12	97-7646	D29	97-7643	H10	94-7341
C2	94-7337	D30	97-7644	I1	94-7342
C4	95-7407	D32	94-7281	I2	94-7343
C5	97-7647	D33	94-7282	I3	94-7344
C6	97-7648	D34	97-7649	J1	95-7413
D1	94-7268	D35	97-7650	J2	94-7345
D2	94-7269	D41	94-7287	J3	94-7346
D3	95-7408	D43	97-7651	L1	94-7348
D4	95-7409	D47	94-7350	L4	94-7356
D5	94-7270	D53	94-7353	M1	95-7414
D6	94-7271	D54	94-7354		

